



**PLUMBERS
SPECIALTY SUPPLY**
www.plumbss.com

TWO HANDLE BASIN FAUCET INSTALLATION INSTRUCTIONS

Thank you for purchasing a PSS faucet. By following the care instructions on this page you will enjoy this quality faucet for many years to come.

Care Instructions

To clean, wipe gently with a soft, damp cloth, then wipe dry. The faucet finish is very durable, however to ensure a long lasting luster, harsh abrasives or polishes should be avoided.

Mounting Method

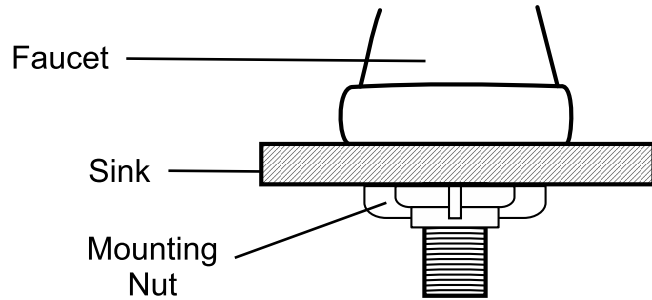

Included In Box

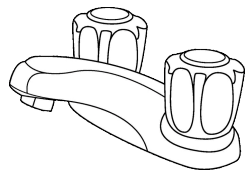

Faucet

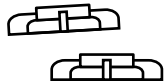

Mounting Nut X 2



Acrylic Handles
(Optional)

TO INSTALL:

- 1 Turn off water supply at valves or main shut off.
- 2 Position faucet on the sink. From underneath sink, secure faucet with mounting nuts. Hand-tighten nuts, check faucet position, then tighten with wrench.
- 3 Apply thread tape or compound (not included) to male faucet threads. Attach water supply lines (not included) to faucet and valves.
- 4 Make sure all connections are tight and turn on water supply. Check for leaks.
- 5 Unscrew and remove aerator. Run hot and cold water uninterrupted for about 1 minute to remove any residue from the lines. Replace aerator.

ITEMS REQUIRED

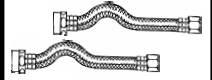

WATER SUPPLY
LINES X2



THREAD TAPE



ADJUSTABLE
WRENCH

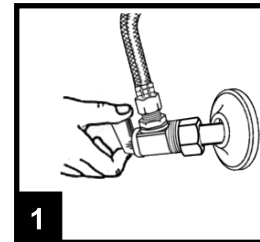

1

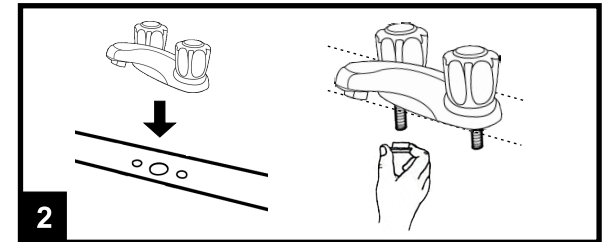

2

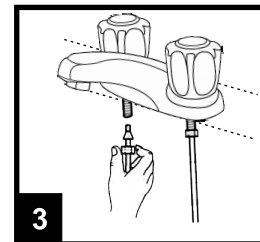

3

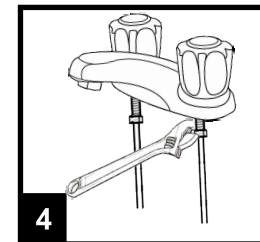

4

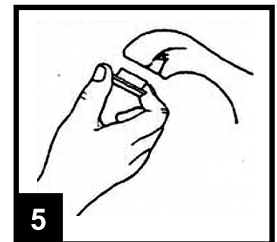

5



This product has been tested and is in compliance with the following standard:

ASME A112.18.1 / CSA B125.1



This product is in compliance with low lead requirements to have no more than a weighted average lead content of 0.25% on wetted surfaces.



Merci pour l'achat d'un robinet PSS. Par suite de la soin et des instructions d'utilisation sur cette page vous pouvez apprécier ce robinet de qualité pour de nombreuses années à venir.

Instructions De Soins

Pour nettoyer, essuyer doucement avec un chiffon doux et humide, puis séchez. La finition du robinet est très durable, mais pour s'assurer à long éclat durable. Abrasifs ou de cirages doivent être évités.

Méthode De Montage

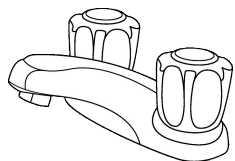
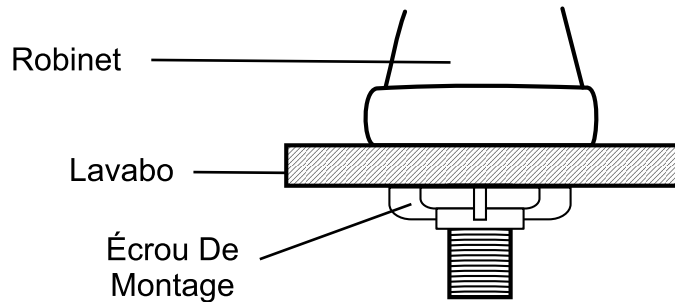

Robinet

Inclus Dans La Boîte

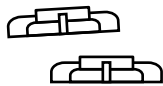

Écrou De Montage X 2



Poignée En Acrylique (Optionnel)

ROBINET DE LAVABO - DEUX POIGNÉE LES INSTRUCTIONS D'INSTALLATION

POUR INSTALLER:

- 1 Éteindre l'alimentation en eau à vannes ou principale d'arrêt.
- 2 Positionner le robinet sur l'évier. À partir de sous l'évier, fixez le robinet avec écrous de montage serrez à la main les écrous, vérifiez la position du robinet, puis serrer avec la clé.
- 3 Appliquer du ruban (non incluse) sur le filetage du robinet mâle. Attachez l'approvisionnement en eau (non incluse) au robinet et vannes.
- 4 Assurez-vous que toutes les connexions sont bien serrées et activer l'alimentation en eau. Vérifier les fuites
- 5 Dévisser et retirer l'aérateur. Couler l'eau chaude et froide pendant une minute pour enlever tout résidu des conduites d'eau. Remettez l'aérateur.

OUTILS NÉCESSAIRES

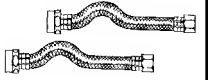

L'APPROVISIONNEMENT EN EAU X2



RUBAN DE SCELLAGE



CLÉ ADJUSTABLE

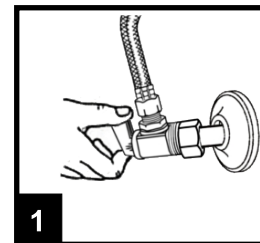

1

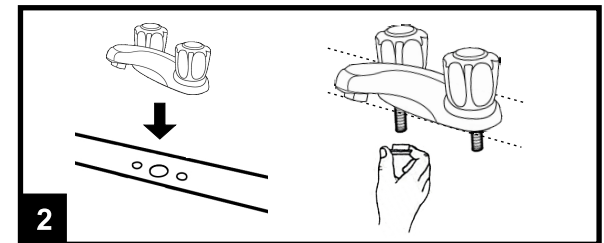

2

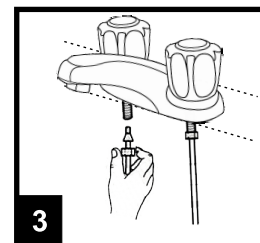

3

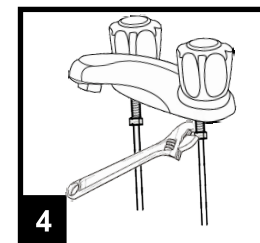

4

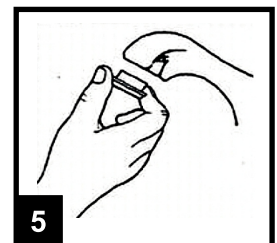

5



Ce produit a été testé et est en conformité avec la norme suivante:

ASME A112.18.1 / CSA B125.1



Ce produit est conforme aux exigences de bas en plomb de ne pas dépasser une teneur en plomb moyenne pondérée de 0.25% sur les surfaces mouillées.